



# BONDI WOOD HEATER



[regency-fire.com.au](http://regency-fire.com.au)





CONTEMPORARY STYLE — ULTIMATE FLEXIBILITY

Bondi freestanding on custom bench with decorative flue

## BONDI WOOD HEATER

Designed for modern living, the Bondi Wood Heater adapts effortlessly to any space. Choose the sleek stacker with its concealed storage and sliding door for a clean, minimalist look. Prefer a bold statement? The wide bench option adds a striking focal point to any room. Or go fully custom with a base that fits your customers unique style.

With optional fan integration in the stacker and bench configurations—or a streamlined, fan-free installation—the Bondi delivers warmth and ambiance exactly how you want it. Give your customers more choices, more style, and more ways to create the perfect space.



GLASS VIEWING AREA	
Width	460 mm
Height	260 mm

### STANDARD FEATURES

- Heats up to 250 sq. mtr\*
- Large black frit glass viewing area for contemporary styling
- Power output: 11kW Emissions: 0.5 g/kg
- Cast Iron lined steel firebox
- 8mm Steel Top Baffle
- 15 year limited warranty
- Automated Airwash system
- 450mm log length
- Overnight burn\*\*

\* Performance may vary based on home floor plan, layout, insulation, and wood quality and/or moisture content

\*\*6-8 hour standard Burn times vary based on fuel and loading technique

### OPTIONS

- **Stacker base** including sliding front door and 2 speed thermostatically controlled fan
- **Side stacker** including sliding front door – can be used either left or right side
- **Wide bench** (1280mm) including 2 speed thermostatically controlled fan
- **Low base** without fan
- **Leg base** without fan

# DIMENSIONS

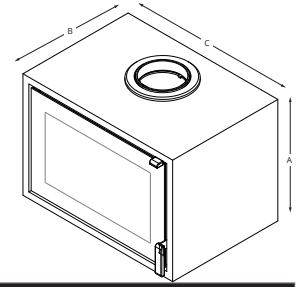
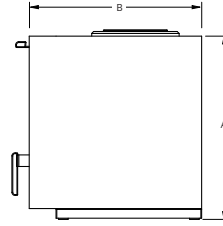
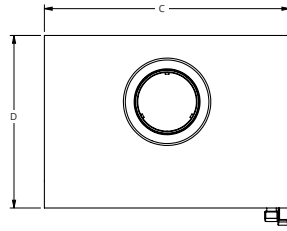
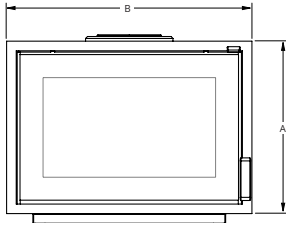

BONDI WOOD HEATER DIMENSIONS			
	A1 - HEIGHT	B - DEPTH	C - WIDTH
<b>BODY</b>	502 mm	475 mm	660 mm
<b>BODY ON STACKER</b>	932 mm	475 mm	660 mm
<b>BODY ON BENCH</b>	954 mm	475 mm	1280 mm
<b>BODY ON LEGS</b>	832mm	475mm	660mm
<b>BODY ON LOW BASE</b>	774mm	475mm	660mm

BONDI CLEARANCES*			
REAR	SIDE	CORNER	HEARTH (FRONT)
160 mm	400 mm	200 mm	300 mm

\*Clearances when using a standard default flue kit (mesh or solid outer) or AHD special insulated flue kit.  
Please refer manual for specific requirements.

Bondi Legs Kit

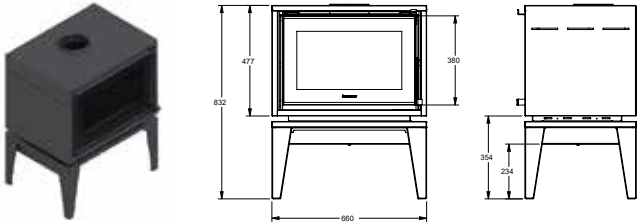

Bondi Side Wood Stacker

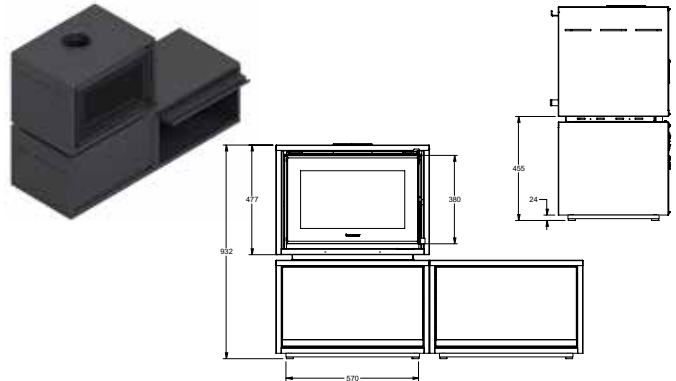

Bondi Low Base

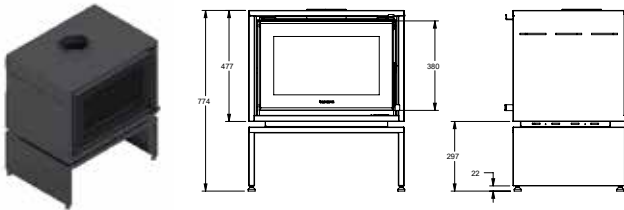

Bondi Bench with Fan Kit

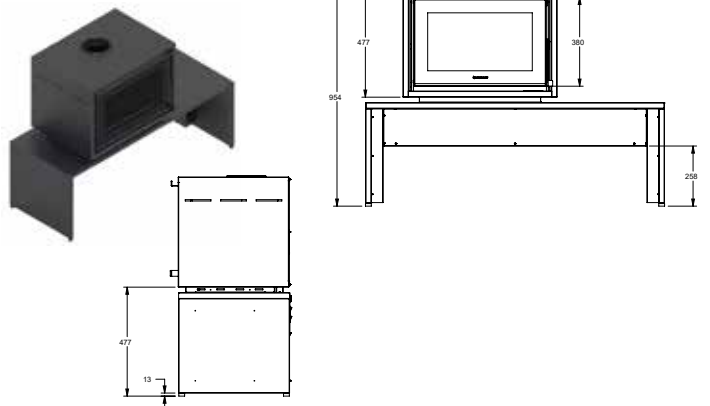

Bondi Wood Stacker with Fan Kit

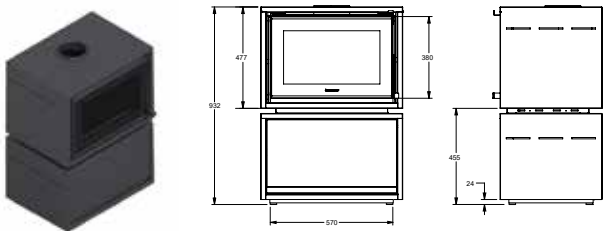

Fireplace Products Australia Pty Ltd.  
99 Colemans Road,  
Dandenong South, Vic, 3175, Australia  
Phone: 1 800 081 978  
Email: sales@regency-fire.com.au

Distributor WA  
Air Group Australia  
131 Bannister Road,  
Canning Vale WA 6155, Australia  
Phone: 08 9350 2200

Your Regency Dealer