

U31 Gas Insert

Model	U31-NG10	U31-LP10
Fuel Type	Natural Gas	Propane
Minimum Supply Pressure	5" W.C. (1.25 kPa)	12" W.C. (2.99 kPa)
Manifold Pressure - High	3.5" W.C. (0.87 kPa)	10" W.C. (2.49 kPa)
Manifold Pressure - Low	1.6" W.C. (0.40 kPa)	6.4" W.C. (1.59 kPa)
Orifice Size - Altitude 0-2000 ft.	#37 DMS	#52 DMS
Orifice Size - Altitude 2000-4500 ft.	#40 DMS	#53 DMS
Minimum Input Altitude 0-2000 ft. (0-610m)	20,600 BTU/h (6.04kW)	22,000 BTU/h (6.45 kW)
Minimum Input Altitude 2000-4500 ft. (610-1372m)	19,200 BTU/h (5.62 kW)	20,000 BTU/h (5.86 kW)
Maximum Input Altitude 0-2000 ft. (0-610m)	30,000 BTU/h (8.79 kW)	28,000 BTU/h (8.21 kW)
Maximum Input Altitude 2000-4500 ft. (610-1372m)	27,200 BTU/h (7.97 kW)	25,000 BTU/h (7.33 kW)
Vent Sizing	4" B-Vent	4" B-Vent

Approved Venting Systems

Flex Vent Systems: FPI AstroCap™ Flex Vent



UNIT DIMENSIONS WITH STANDARD FACEPLATE

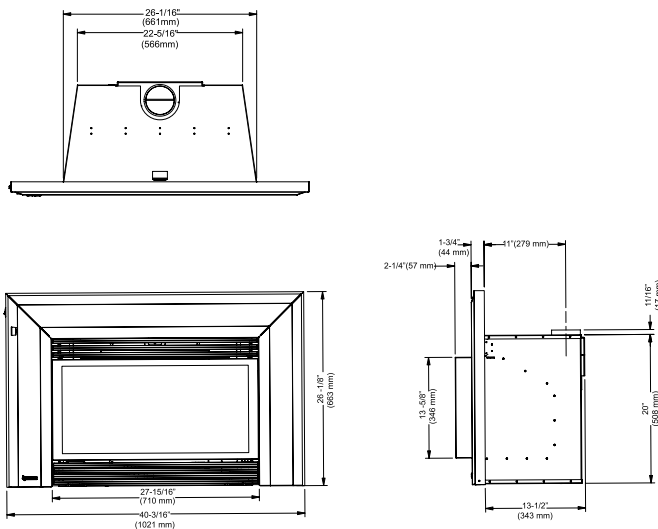

UNIT DIMENSIONS WITH LOW PROFILE FACEPLATE

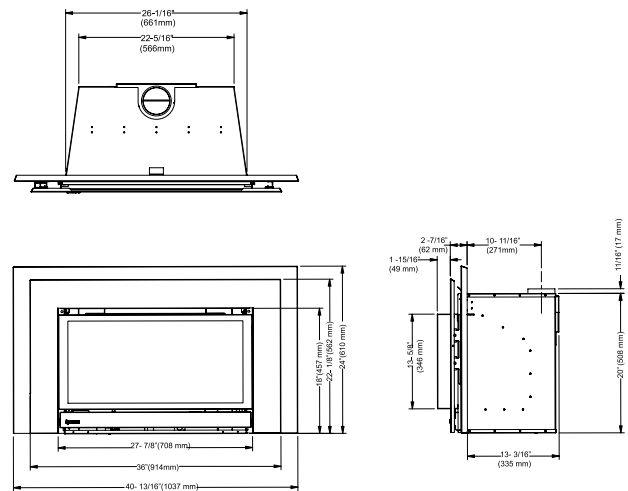

MINIMUM FIREPLACE DIMENSIONS

The minimum fireplace dimensions for the FPI gas fireplace insert are shown in the following diagrams:

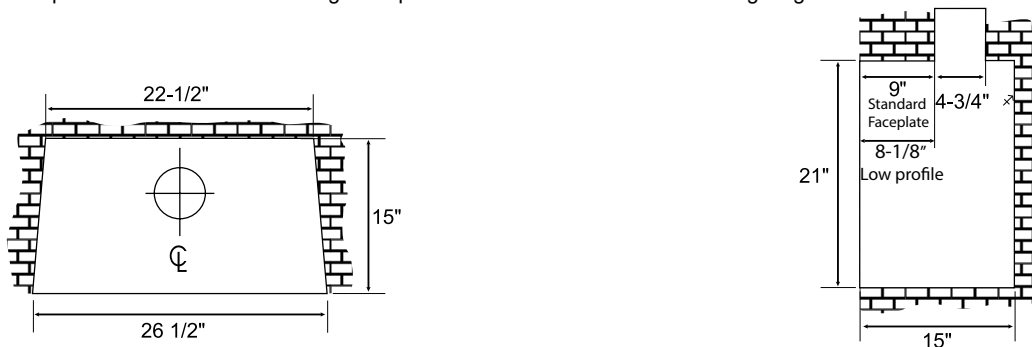

Clearances

Unless otherwise stated the clearances listed below are Minimum distances to combustible materials. **Please Note: A major cause of chimney related fires is due to a failure to maintain required clearances (air space) to combustible materials. It is of the greatest importance that this fireplace and vent system be installed only in accordance with these instructions.**

From Unit

Sides	A 10" / 255 mm
Ceiling	B 47.5" / 1205 mm
Mantle	C See mantle clearances
Max. Mantel Depth	G 12" / 305 mm
Min. Alcove Width	K 48" / 1220 mm
Max. Alcove Depth	L 36" / 915 mm

* No Hearth Required

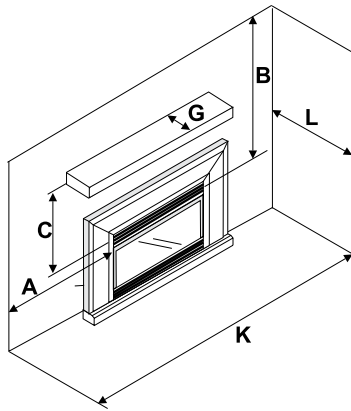

Clearances for Standard Faceplate /
Low Profile Faceplate without Safety Screen

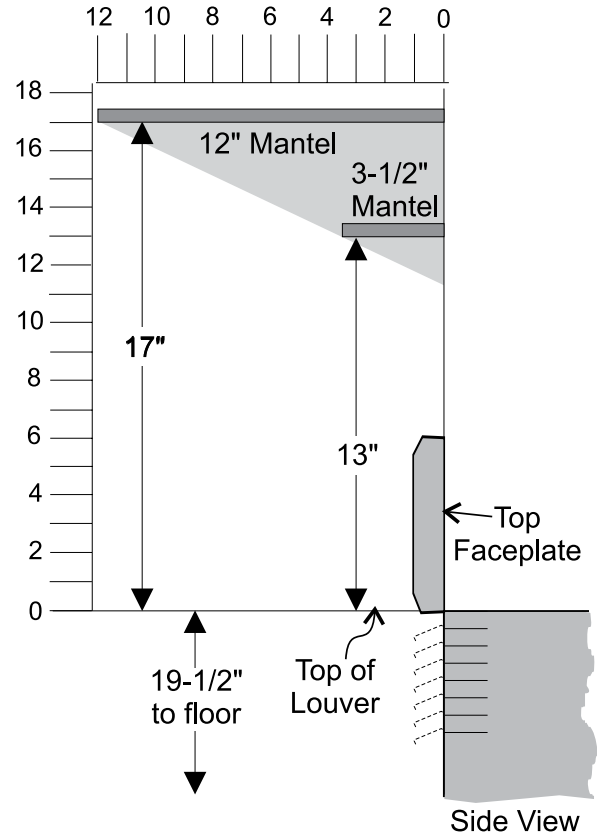

Clearances for Low Profile Faceplate with Safety Screen

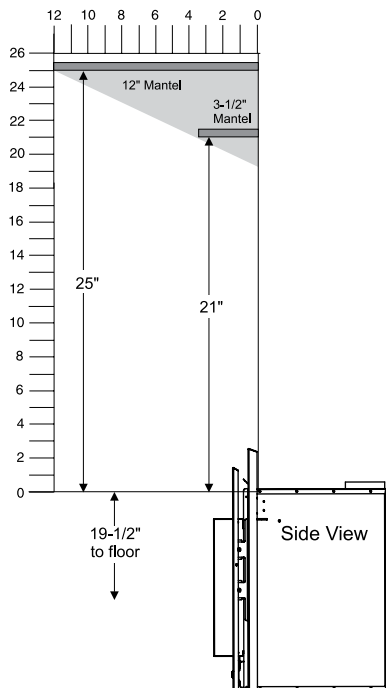

VENTING

THE APPLIANCE MUST NOT BE CONNECTED TO A CHIMNEY FLUE SERVING A SEPARATE SOLID FUEL BURNING APPLIANCE.

This appliance is designed to attach to a 4" diameter type B-Vent or listed gas fuel type vent liner running the full length of the chimney. A minimum flue height of 12 feet is recommended. B-Vent must be supported by a vent support - supplied by vent manufacturer. See chart on this page for minimum distances from roof.

The FPI Insert incorporates its own internal draft hood, so no additional external draft hood is required.

Periodically check that the vent is unrestricted and an adequate draft is present when the unit is in operation. (See page 8 for spillage test.) Before installing vent system ensure that the damper plate is open and secure to prevent the damper plate from falling down and crushing the liner.

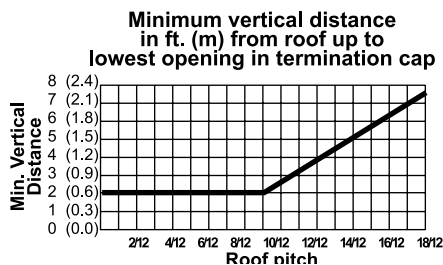
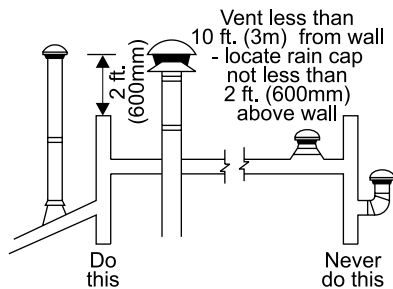

WARNING: Operation of this appliance when not connected to a properly installed and maintained venting system or tampering with the blocked vent shutoff system can result in carbon monoxide (CO) poisoning and possible death.

Combustion and Ventilation Air

WARNING: This appliance needs fresh air for safe operation and must be installed with provisions for adequate combustion and ventilation air available to the room in which it is to be operating.

Follow CAN/CGA B149 (in Canada) or ANSI Z223.1 (in the USA) requirements, and any local codes or regulations of the enforcing authority.

Air for combustion is drawn in through the front of the unit, therefore, the front of the unit must be kept clear of any obstructions.