

U39E-12 Freestanding Gas Stove

Model	U39E-NG12	U39E-LP12
Fuel Type	Natural Gas	Propane
Minimum Supply Pressure	5" W.C. (1.25 kPa)	11" W.C. (2.74 kPa)
Manifold Pressure - High	3.5" W.C. (0.87 kPa)	10" W.C. (2.49 kPa)
Manifold Pressure - Low	1.6" W.C. (0.40 kPa)	6.4" W.C. (1.59 kPa)
Orifice Size Altitude 0-2000ft (0-610m)	#32	#49
Orifice Size Altitude 0-4500ft (0-1370m)	#35	#51
Minimum Input Altitude 0-2000ft (0-610m)	26,000 BTU/h	30,000 BTU/h
Minimum Input Altitude 0-4500ft (0-1370m)	24,000 BTU/h	26,000 BTU/h
Maximum Input Altitude 0-2000ft (0-610m)	38,000 BTU/h	38,000 BTU/h
Maximum Input Altitude 0-4500ft (0-1370m)	35,000 BTU/h	32,500 BTU/h
Vent Sizing	4" Inner / 6-5/8" Outer	4" Inner / 6-5/8" Outer
CSA P.4.1	73.19%	75.68%



Approved Venting Systems	
Flex Vent Systems:	FPI AstroCap™ Flex Vent
Rigid Pipe Vent Systems:	Simpson Direct Vent Pro® American Metal Products® Amerivent Direct Security Secure Vent® Selkirk Direct-Temp™ Metal-Fab® Sure Seal

Dimensions

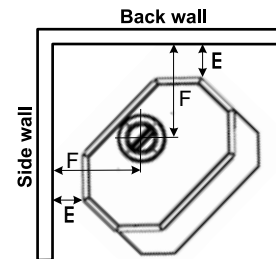
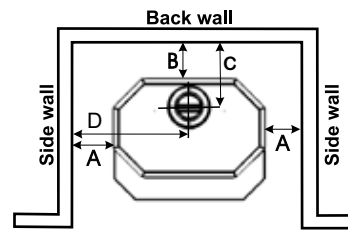
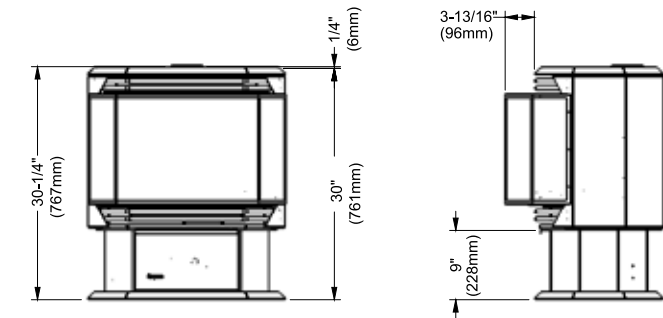
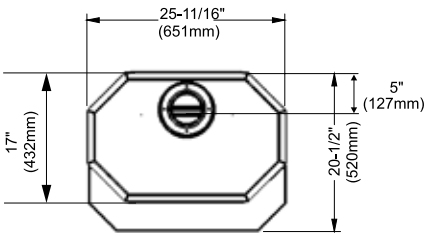

Use the minimum clearances shown in the diagrams below:

U39E-NG12 & U39E-LP12 Clearances

- A Side Wall to Unit 7-1/2" / 190 mm
- B Back Wall to Unit 6" / 150 mm
- E Side Wall to Unit 2" / 50 mm

U39E-NG12 & U39E-LP12 Reference Dimensions

- C Back Wall to Flue Centerline 11 1/2" / 280 mm
 - D Side Wall to Flue Centerline 20-1/2" / 521 mm
 - F Side Wall to Flue Centerline 11" / 280 mm
- Minimum ceiling height is 36" / 914 mm from top of unit.

Regency Direct Vent System Horizontal Terminations Only

These venting systems, in combination with the **U39** Direct Vent Gas Fireplace, have been tested and listed as a direct vent heater system by Warnock Hersey. The location of the termination cap must conform to the requirements in the Vent Terminal Locations diagram.

FPI Horizontal Termination Kit includes all the necessary parts needed to install the U39.

FPI Kit #	Length	Contains:
#946-116	2 Feet	<ol style="list-style-type: none"> 6-5/8" Rigid Pipe Section (Kit length) 4" flexible liner (Kit length) spring spacers (4) 90° Elbow Adjustable pipe section 13-1/2" to 24" thimble cover (1) thimble (1) adaptor AstroCap termination cap (1) trim collar (2)
#946-216	4 Feet	<ol style="list-style-type: none"> tube of Mill Pac (1) S.S. screws #8 x 1-1/2", self-tap, (12) Blk. screws #8 x 1-1/2", self-tap, (14) Blk. screws #8 x 1-1/2" drill point, (4) S.S. screws #8 x 1-1/2" drill point, (4) Wood screws #8 x 1" (8) vinyl siding standoff (optional #946-206)

Notes:

- Liner sections should be continuous without any joints or seams.
- Only Flex pipe purchased from Regency may be used for Flex installations.
- Horizontal sections must be supported every 3 feet.

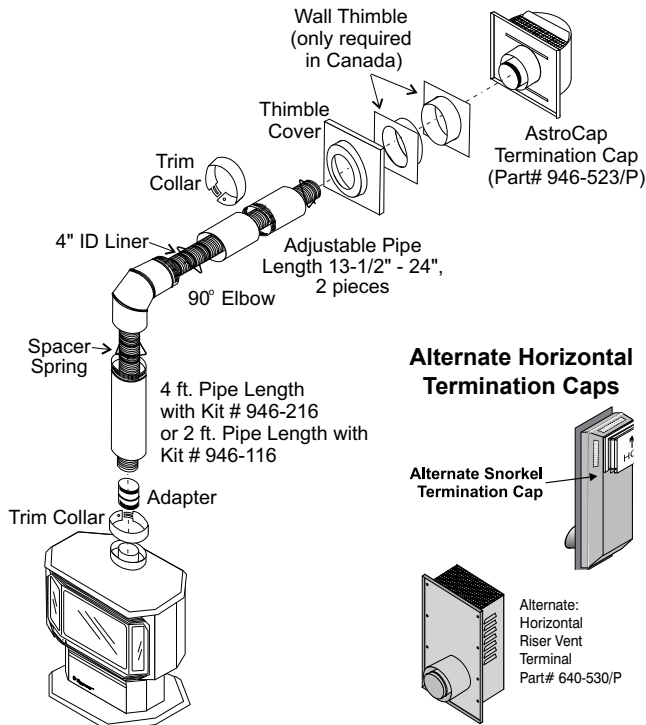

Vent Restrictor Position

To set the Vent restriction as indicated in the diagram, simply loosen the screws and push the vent restrictor plate to the correct position. Tighten the screws.

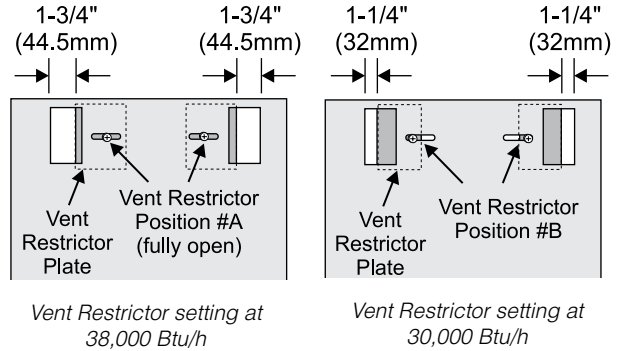

Rigid Pipe Venting Systems Horizontal or Vertical Terminations

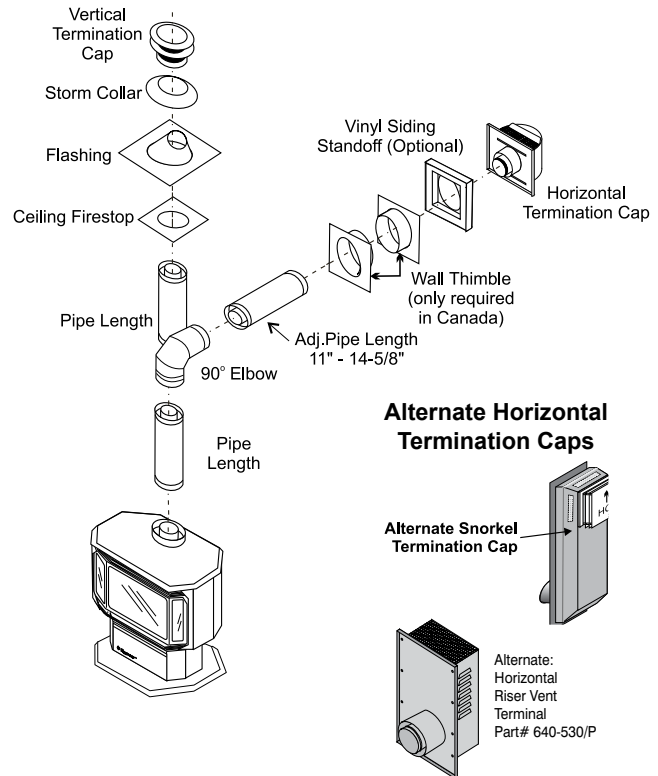

If required by the external termination location the listed alternate termination caps may be used.

Vent Restrictor Position

Vent restriction is required for certain venting installations, see the diagrams in "Venting Arrangement" section to determine if they are required for your installation.

The vent restrictor has three settings: "C" Center (factory setting), "L" Left, and "R" Right. Simply loosen the screws and push the vent restrictor plate to the correct position. Tighten the screws.

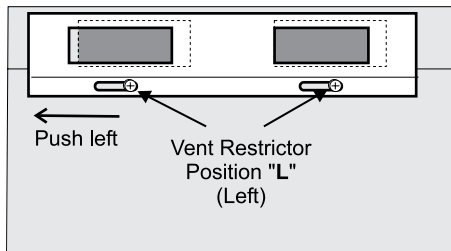
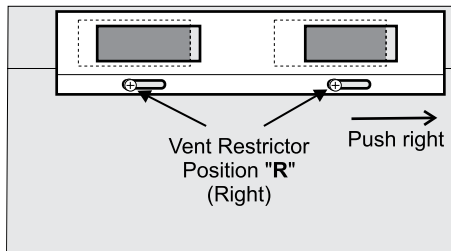
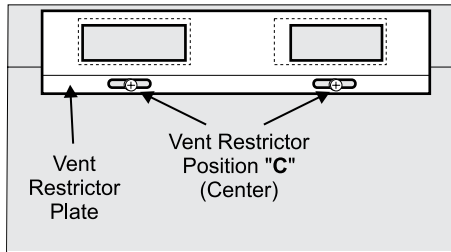

Rigid Pipe Venting Systems Horizontal or Vertical Terminations

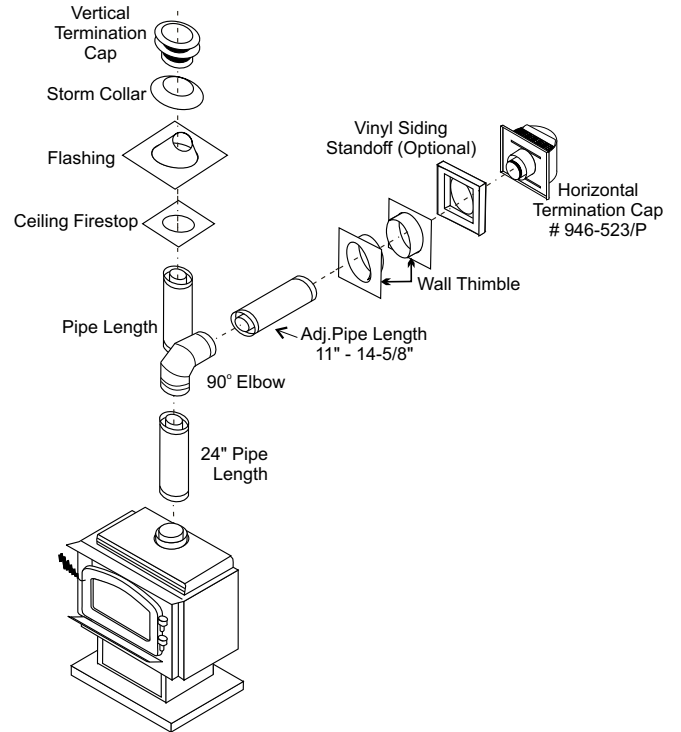

U39E-12 Gas Stove

Venting Arrangements - Vertical Terminations Rigid Pipe System (Propane & Natural Gas)

The C34 is approved for a maximum 30 ft. straight vertical, with Rigid Pipe vent systems for Propane and Natural Gas.

The shaded area in the diagram (right) shows allowable venting configurations with a maximum of two 45° elbows allowed. Terminations falling in the shaded area must have the Vent Restrictor Position set to "R" Right.

- **Vent must be supported at offsets.**
- **Horizontal sections must be supported every 3 feet**
- **Firestops are required at each floor level and whenever passing through a wall.**
- **Maintain clearances to combustible materials.**
- **Minimum of 1' pipe section between elbows.**

Vertical Venting with Two (2) 90° Elbows

Two 45° elbows = One 90° elbow

Option	V	H	V+ V1	Maximum total pipe length, of all sections, must not exceed 30 feet. Total horizontal sections must not exceed 8 feet. Minimum of 1 foot between 90° elbows is required.
A)	1' Min.	4' Max.	2' Min.	
B)	2' Min.	5' Max.	3' Min.	
C)	3' Min.	6' Max.	4' Min.	
D)	4' Min.	7' Max.	5' Min.	
E)	5' Min.	8' Max.	6' Min.	

Vent Restrictor in position "C" (Center),

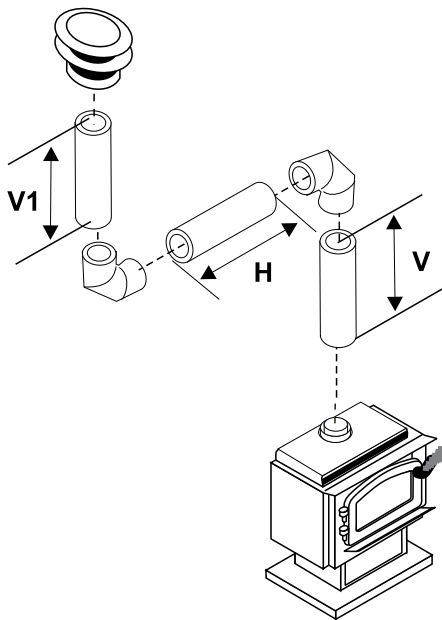

Venting Arrangements Vertical Termination Systems for Residential Manufactured and Mobile Homes

The shaded area in the diagram below shows all allowable combinations of straight vertical and offset to vertical runs with vertical terminations. Maximum two 45° elbows.

All vertical and offset to vertical vent installations require Vent Restrictor Position "R" (Right). If the vent is ENCLOSED in a chase (min. size 9" x 9") maintain a 1-1/4" clearance to combustibles.

May be installed in Manufactured (Mobile) Homes after first sale.

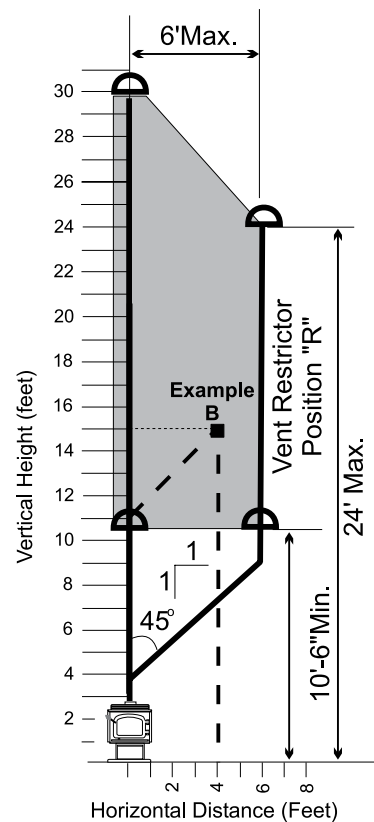

Straight Vertical and Offset to Vertical Terminations use Vent Restrictor Position "R" (Right)

If you are terminating within this shaded area, Vent Restrictor Position "R" (Right) must be used.

Venting Arrangements Horizontal Terminations for All Venting Systems

The shaded areas in the diagram below show all allowable combinations of vertical runs with horizontal terminations. Maximum one 90° elbow (two 45° elbows equal one 90° elbow).

Propane and Natural Gas: Residential, Manufactured and Mobile Homes Installations

The venting arrangements diagrammed below, have a min. of 75% (flue loss) efficiency with Fan Off, as required for manufactured homes. (Actual efficiency may be as high as 85%)

May be installed in Manufactured (Mobile) Homes after first sale.

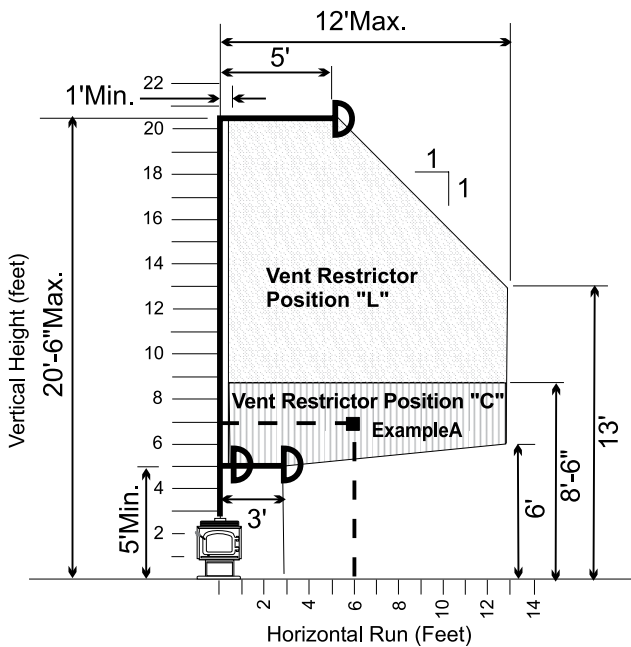

- If you are terminating within this shaded area, Vent Restrictor Position "L" (Left) must be used.
- If you are terminating within these shaded areas, Vent Restrictor Position "C" (Center) is required

Horizontal Venting with Two (2) 90° Elbows

Two 45° elbows = One 90° elbow

Option	V	H + H1	Maximum total pipe length, of all sections, must not exceed 30 feet. Total horizontal sections must not exceed 8 feet. Minimum of 1 foot between 90° elbows is required.
A)	4' Min.	6' Max.	
B)	5' Min.	7' Max.	
C)	6' Min.	8' Max.	

Vent Restrictor in position "C" (Center).

