

U39 Top Vent Gas Stove

Model	U39-NG10	U39-LP10
Fuel Type	Natural Gas	Propane
Minimum Supply Pressure	5" W.C. (1.25 kPa)	12" W.C. (3.00 kPa)
Manifold Pressure - High	3.8" W.C. (0.94 kPa)	11" W.C. (2.74 kPa)
Manifold Pressure - Low	1.1" W.C. (0.27 kPa)	2.9" W.C. (0.72 kPa)
Orifice Size Altitude 0-2000ft (0-610m)	#32	#50
Orifice Size Altitude 2000-4500ft (610-1370m)	#33	
Orifice Size 30,000 Max BTU	#37	#52
Minimum Input Altitude 0-2000ft (0-610m)	20,000 BTU/h	20,000 BTU/h
Minimum Input Altitude 2000-4500ft (610-1370m)	19,000 BTU/h	
Minimum Input Converted to 30,000 Max BTU	15,000 BTU/h	15,000 BTU/h
Maximum Input Altitude 0-2000ft (0-610m)	38,000 BTU/h	38,000 BTU/h
Maximum Input Altitude 2000-4500ft (610-1370m)	36,100 BTU/h	
Maximum Input converted to 30,000 Max BTU	30,000 BTU/h	30,000 BTU/h
Vent Sizing	4" Inner / 6-5/8" Outer	4" Inner / 6-5/8" Outer

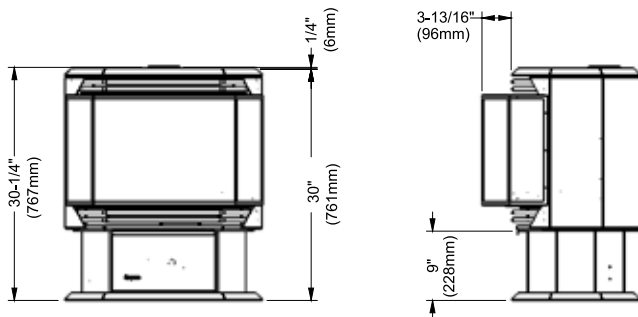

Approved Venting Systems	
Flex Vent Systems:	FPI AstroCap™ Flex Vent
Rigid Pipe Vent Systems:	Simpson Direct Vent Pro® American Metal Products® Amerivent Direct Security Secure Vent® Selkirk Direct-Temp™ Metal-Fab® Sure Seal

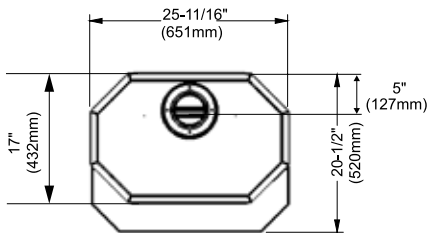
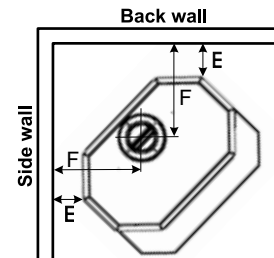
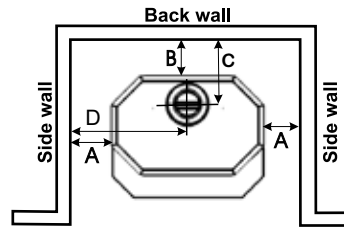

Use the minimum clearances shown in the diagrams below:

U39-NG10 & U39-LP10 Clearances

- A Side Wall to Unit 7-1/2" / 190 mm
- B Back Wall to Unit 6" / 150 mm
- E Side Wall to Unit 2" / 50 mm

U39-NG10 & U39-LP10 Reference Dimensions

- C Back Wall to Flue Centerline 11"/280 mm
 - D Side Wall to Flue Centerline 20-1/2"/521 mm
 - F Side Wall to Flue Centerline 11"/280 mm
- Minimum ceiling height is 36" / 914 mm from top of unit.

U39 Gas Stove

Regency Direct Vent System Horizontal Terminations Only

These venting systems, in combination with the **U39** Direct Vent Gas Fireplace, have been tested and listed as a direct vent heater system by Warnock Hersey. The location of the termination cap must conform to the requirements in the Vent Terminal Locations diagram.

FPI Horizontal Termination Kit includes all the necessary parts needed to install the U39.

FPI Kit #	Length	Contains:
#946-116	2 Feet	<ol style="list-style-type: none"> 6-5/8" Rigid Pipe Section (Kit length) 4" flexible liner (Kit length) spring spacers (4) 90° Elbow Adjustable pipe section 13-1/2" to 24" thimble cover (1) thimble (1) adapter AstroCap termination cap (1)
#946-216	4 Feet	<ol style="list-style-type: none"> trim collar (2) tube of Mill Pac (1) S.S. screws #8 x 1-1/2", self-tap, (12) Blk. screws #8 x 1-1/2", self-tap, (14) Blk. screws #8 x 1-1/2" drill point, (4) S.S. screws #8 x 1-1/2" drill point, (4) Wood screws #8 x 1" (8) vinyl siding standoff (optional #946-206)

Notes:

- Liner sections should be continuous without any joints or seams.
- Only Flex pipe purchased from Regency may be used for Flex installations.
- Horizontal sections must be supported every 3 feet.

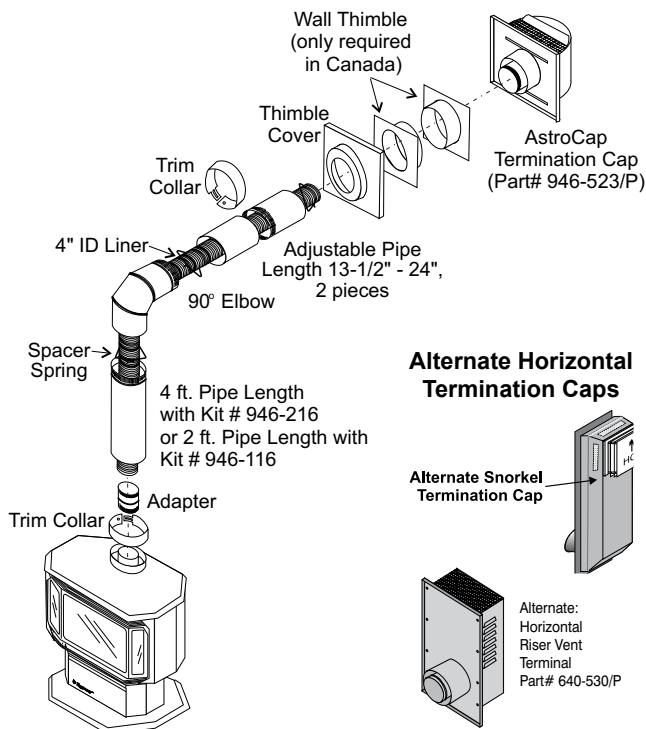

If required by the external termination location the listed alternate termination caps may be used.

Vent Restrictor Position

To set the Vent restriction as indicated in the diagram, simply loosen the screws and push the vent restrictor plate to the correct position. Tighten the screws.

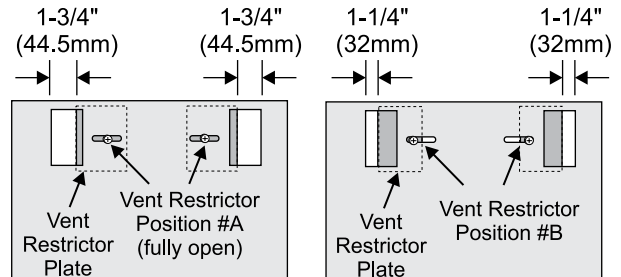

Vent Restrictor setting at 38,000 Btu/h

Vent Restrictor setting at 30,000 Btu/h

Rigid Pipe Venting Systems

Horizontal or Vertical Terminations

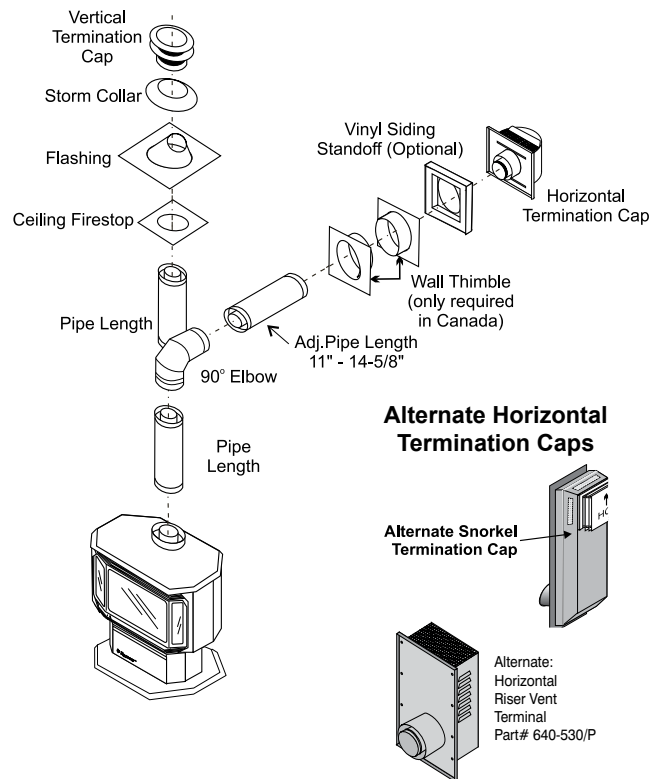

Alternate Horizontal Termination Caps

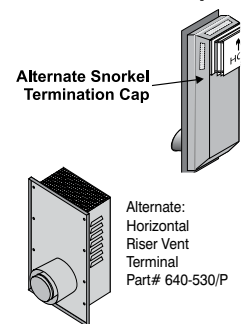

Alternate: Horizontal Riser Vent Terminal Part# 640-530/P

Horizontal Terminations for All Venting Systems

The shaded areas in the diagram show all allowable combinations of vertical runs with horizontal terminations. Maximum one 90° elbow (two 45° elbows equal one 90° elbow).

Propane and Natural Gas:
Residential, Manufactured and Mobile Homes Installations

The venting arrangements diagrammed below, have a min. of 75% (flue loss) efficiency with Fan Off, as required for manufactured homes. (Actual efficiency may be as high as 85%)

May be installed in Manufactured (Mobile) Homes after first sale.

Horizontal Venting with Two (2) 90° Elbows

One 90° elbow = Two 45° elbows.

Option	V	H + H1
A)	3' Min.	2' Max.
B)	5' Min.	3' Max.
C)	8' Min.	4' Max.

With these options, maximum total pipe length is 30 feet with minimum of 8 feet total vertical and maximum 4 feet total horizontal.

Please note minimum 1 foot between 90° elbows is required.

Lengths do not include elbow indicated

Vent restrictor position A (fully open), Refer to the "Venting Arrangement" section.

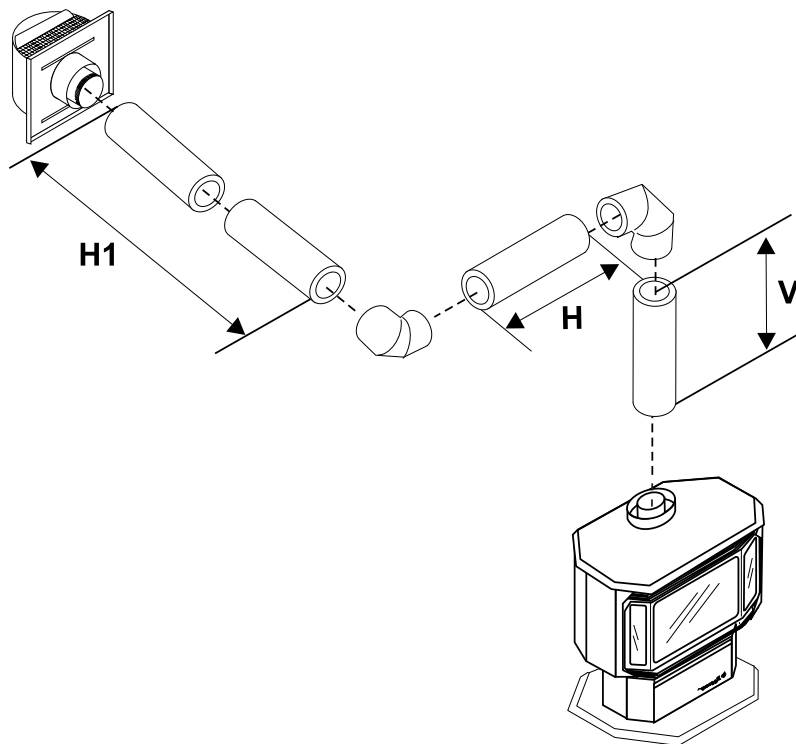
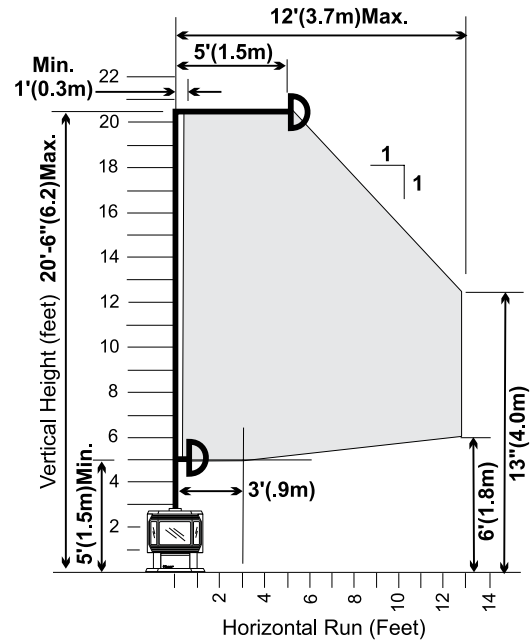

Vertical Terminations using Rigid Pipe Systems

The shaded area in the diagram below shows all allowable combinations of straight vertical and offset to vertical runs with vertical terminations. Maximum two 45° elbows.

If the vent is ENCLOSED in a chase (min. size 9" x 9") maintain a 1-1/4" clearance to combustibles.

May be installed in Manufactured (Mobile) Homes after first sale.

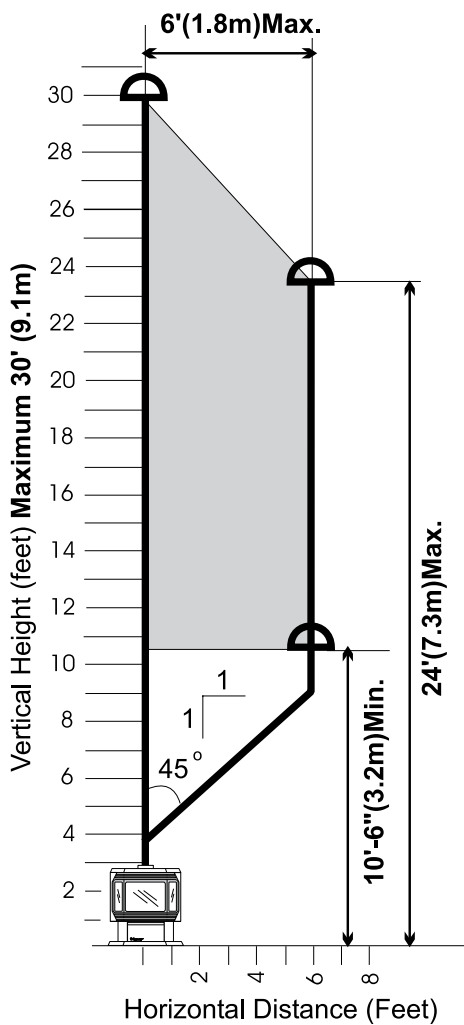

Vertical Venting with Two (2. 90° Elbows)

Two 45° elbows = One 90° elbow

Option	V	H	V+ V1	Maximum total pipe length, of all sections, must not exceed 30 feet.
A)	1' Min.	1' Max.	2' Min.	Total horizontal sections must not exceed 4 feet.
B)	1' Min.	2' Max.	3' Min.	
C)	2' Min.	3' Max.	4' Min.	Minimum of 1 foot between 90° elbows is required.
D)	2' Min.	4' Max.	4' Min.	

Vent Restrictor in position "A" (Center)

